

Technical data, locations and marking on the equipment

1 – Frontal attachment element, 2 – Hip attachment element, 3 – Sternal attachment element, 4 – Dorsal attachment element, 5 – Shoulder attachment element, 6 – Loops to fasten chest ascender, 7 – Chest harness-seat harness connector, 8 – Speed buckle for adjusting waist belt strap, 9 – Speed buckle for adjusting leg loop strap, 10 – Easy Lock buckle for adjusting shoulder strap, 11 – Easy Lock buckle for adjusting dorsal element, 12 – Additional loop with a bearing capacity of 5 kg, 13 – Lanyard parking attachment, 14 – Fall arrest indicator, 15 – Shoulder strap, 16 – Waist belt strap, 17 – Leg loop strap, 18 – Connecting strap, 19 – Front waist belt part, 20 – Name tag, 21 – Elastic keeper for strap, 22 – Identification and methodical label, 23 – Reflective stripe on the shoulder and waist belt, 24 – Gear loop, 25 – Buckle for attachment dorsal shoulder and seat harness, 26 – Waist belt padding, 27 – Leg loop padding, 28 – Shoulder padding, 29 – ANSI label

FALL ARREST INDICATOR
Check before each use.

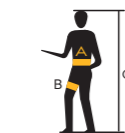
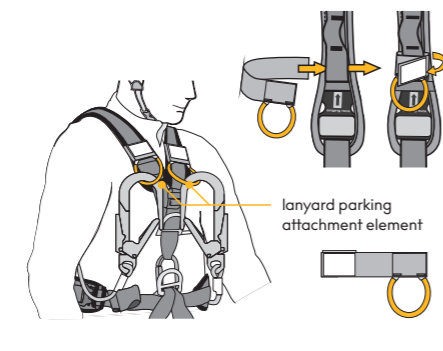
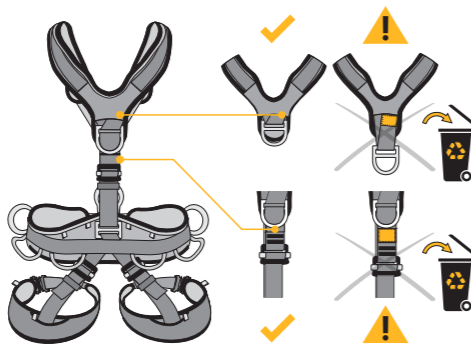

		S	M/L	XL
EXPERT 3D SPEED STEEL m [g] M/L = 2 830	A [cm/in]	65–80 / 25–31	85–100 / 33–39	90–130 / 35–51
	B [cm/in]	45–60 / 18–24	50–75 / 19–29	50–75 / 19–29
	C [cm/ft]	150–170 / 4.92–5.57	160–180 / 5.25–5.9	175–205 / 5.74–6.73

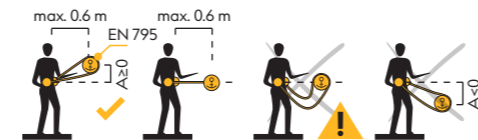
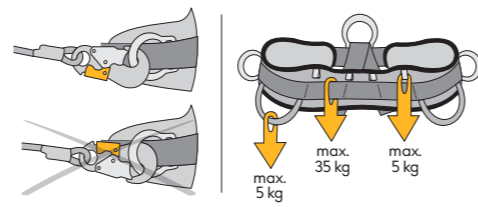

MRL = 150 kg

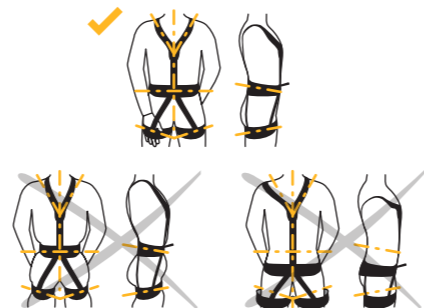

This harness meets the life safety harness requirements of NFPA 1983, standard on life safety rope and equipment for emergency services, 2017 edition; class III.

Composition of basic materials:
Straps: polyamid, polyester.
Adjustment buckles: steel.

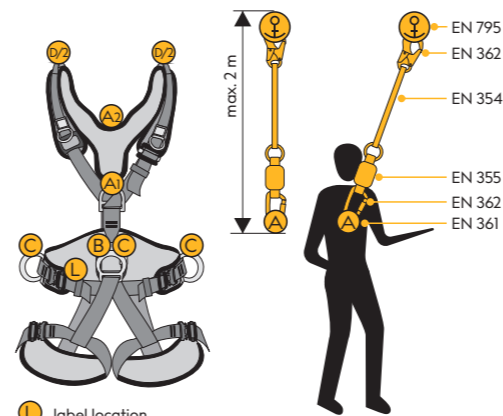

L label location

	NFPA class III life safety harness		EN standard	
A1	Head up	16 kN	Fall arrest attachment element	15 kN EN 361:2002
	Head down	10 kN		10 kN EN 361:2002
A2	Head up	16 kN	Fall arrest attachment element	15 kN EN 361:2002
	Head down	10 kN		10 kN EN 361:2002
B	Head up	16 kN	rappel/positioning attachment element	15 kN EN 813:2008
C	Head up	13 kN	positioning only attachment	15 kN EN 358:2018
D	Head up	16 kN	shoulder attachment element	15 kN EN 1497:2007

Nařízení evropského parlamentu a rady (EU) 2016/425 | Regulation (EU) 2016/425
Posouzení shody | Conformity assessment:
V.V.U.U. a.s., Píkatřská 1337/7, Ostrava-Radvanice, Czech Republic, NB 1019
Shoda s typem | Conformity to type:
V.V.U.U. a.s., Píkatřská 1337/7, Ostrava-Radvanice, Czech Republic, NB 1019
EU prohlášení o shodě naleznete na:
EU declaration of conformity available on:
www.singingrock.com

CE 1019
EN 358:2018
EN 361:2002
EN 813:2008
EN 1497:2007
NFPA 1983-2017 Edition

SINGING ROCK ETIKETA SLEDOVATELNOSTI | TRACEABILITY LABEL

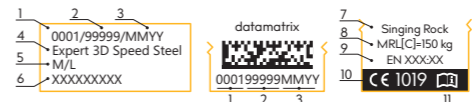

1 CZ jedinečné číslo | EN unique No. | DE Eindeutige nummer | FR Numéro unique | ES Número único
2 výrobní číslo | batch No. | Chargennummer | Numero de lot de fabrication | No. de serie
3 měsíc/rok výroby | month/year of manufacture | produktion monat/jahr | mois/année de fabrication | mes/año de producción
4 model | model | Model | le modèle | modelo
5 velikost | size | Größe | taille | talla
6 označení produktu | product code | Produktcode | code de produit | código de producto
7 výrobce | producer | Hersteller | Le fabricant | fabricante
8 max. jmenovité zatížení | maximum rated load | maximale Nennlast | nominale maximale carga | maxima admisible
9 evropská norma | european standard | Europäische Norm | La norme européenne | Normativa europea
10 značka shody / číslo oznámeného subjektu, který provádí shodu s typem | conformity marking / no. of notified body shell carrying out conformity with type | die Konformität Markierung / nummer die notifizierte Stelle durchführen die entsprechenden Konformität mit type | la marque de conformité / numero di organismo notificato effettuare la conformità avec type | marca de conformidad / numero del organismo notificado efectuar la conformidad con tipo
11 viz návod k použití | read instructions for use | Gebrauchsanweisung beachten | Consulter les instructions d'utilisation | Consulte las instrucciones de uso



CZ Bez důkladného přečtení a pochopení návodu k použití nepoužívejte tento výrobek.
EN Reading and understanding instruction for use are required to use this product.
DE Das Lesen und Verstehen der Bedienungsanweisung ist Voraussetzung für die Nutzung des Produkts.
FR Sans avoir lu attentivement ce mode d'emploi, n'utilisez pas ce produit.
ES Es necesario leer y comprender las instrucciones de uso de este producto.



CZ 3 roky záruka.
EN 3 years guarantee.
DE 3 Jahre Garantie.
FR La garantie de 3 ans.
ES 3 años de garantía.

ver. 16597022405 0121

SINGING ROCK s.r.o.
Poniklá 317 • 514 01 Poniklá • Czech Republic
Tel. +420 481 585 007 • email: info@singingrock.cz
www.singingrock.com



singingrock.page



singingrock_official



EXPERT 3D SPEED STEEL



! WARNING !

The technical information accompanying this product must be used and understood before use. Failure to follow these warnings increases the risk of injury or death. Use and inspect the harness following the manufacturer's instructions. This product must be inspected prior to each use. Do not use the product subjected to impact forces. Any modifications or repair outside of our production facilities is forbidden. Do not remove this label.

NFPA 1983 – 2017 EDITION

User Information

- 1) Inspect the harness periodically according to Singing Rock inspection procedure (see included Guide).
- 2) Remove the harness from service and dispose of carefully; if the harness does not pass the inspection or if there is any doubt about if its safety or serviceability
- 3) Do not expose the harness to flame of high temperatures and carry the harness where it will be protected as the harness could melt or burn and fail if exposed to flame or high temperature.
- 4) Any modification or repair outside of our production facilities is forbidden.
- 5) Keep the product labels and user information/ instruction after they are removed/separated from the harness and retain them in the permanent harness record. Copy the product labels and user information/ instruction and keep the copies with the harness.
- 6) Refer to user information/instruction before and after each use.
- 7) You can be killed or seriously injured if you do not read, understand and follow user instruction/information.
- 8) Additional information regarding safety can be found in NFPA 1500, Standard on Fire Department Occupational Safety and Health Program and in NFPA 1983, Standard on Life Safety Rope and Equipment for Emergency Services.

GUIDE ON HOW TO INSPECT YOUR LIFE SAFETY HARNESS

Definitions

Webbing is woven surface textile of a specific width with edges that do not unravel; **seam** is solid connection of surface textiles by threads, which consists of stitches; **stitch** is part of a seam between two pricks that is formed by upper and lower thread; **metal parts** are metal buckles and other components of various shapes – especially fixing, setting and connecting devices.

How old is the harness

Find this product label or label permanently stitched on the harness.

Is your harness in a good shape?

Keep the records of any events while using the harness. If the harness sustained high factor fall put it out of the service. If the signs of wear or damage specified below are visible, do not use the harness anymore. If the harness is more then 10 years old from the date of manufacture or 5 years old from the date of first use, do not use the any further.

Inspection of Webbing

The inspection is necessary to be done also on less accessible parts, especially on edges and spots where the webbing touches metal devices of the harness. If any yarn is completely broken (cut or worn through), discard the harness from further use. It is especially important to pay attention to both edges of the webbing where the risk of breaking is highest. Filaments in a yarn can be damaged in such a way that the yarn as a whole is not damaged (roughness of webbing). It is not necessary to discard the harness from further use unless the yarn that protects the edge of webbing from unravelling is damaged. Local colouring (stains spots, etc.) wash in the lukewarm water. If the stains or spots do not disappear, damage was caused by unknown

chemical, put the harness out of service at once. Glossy surface also suggests putting the harness out of service immediately. High temperatures are permanently damaging to synthetic fibres.

Inspection of Seam

The inspection is necessary to be done also on less accessible parts of the harness. The basic characteristic of a safety stitch is that no thread (or stitch) is broken, cut, worn through or unravelled. It is also important to check the right and wrong side.

The stitching interruption should be accepted only at conditions, when the sewing threads terminations are sealed from Singing Rock production. If any thread in a seam is completely broken (cut or worn through) and the thread ends are not sealed put the harness out of the service.

If the seam is rough and one of the three yarns is observed under the magnifier completely broken, it is necessary to discard the harness from further use promptly.

Local colouring (stains, spots, etc.) wash in the lukewarm water.

If the stains or spots do not disappear, damage was caused by unknown chemical, put the harness out of service at once. Glossy surface also suggests putting the harness out of service immediately. High temperatures are permanently damaging synthetic fibres.

All the seams in the harness must have the terminations sealed in such a way that a loose end of the thread is not longer than 2 mm and the visible sealed end prevents the seam from spontaneous unravelling. If the loose end of the thread is longer than 8 mm it is necessary to discard the harness from further use because it means that more than two stitches unravel. A loosened stitch is also a reason for discarding the harness from use. A loosened stitch means a loose loop of a stitch that allows inserting a rounded wire with a diameter of 2 mm into it.

Inspection of metal parts

The basic characteristic of safety metal devices is no deformation, and smooth surface without any cracks. If a permanent deformation is visible or the reduction of the original size of the metal device is more than 5 %, do not use the harness anymore. Corrosion and oxidation of metal devices that do not disappear after washing the harness in lukewarm soap water can be described as chemical damage, discard the harness from further use at once.

Reduction of function is important to be checked especially if two devices fit into each other. The function of metal devices is reduced if it can be opened unintentionally or if it does not fit the original requirements. In this case put the harness out of the service.

ANNEX A – ANSI

ANSI/ASSE Z359 Requirements for Proper Use and Maintenance of Full Body Harnesses (note: these are general requirements and information provided by ANSI/ASSE Z359; the manufacturer of this equipment may impose more stringent restrictions on the use of the products they manufacture, see the manufacturer's instructions.)

1. It is essential that the users of this type of equipment receive proper training and instruction, including detailed procedures for the safe use of such equipment in their work application. ANSI/ASSE Z3592, Minimum Requirements for a Comprehensive Managed Fall Protection Program, establishes guidelines and requirements for an employer's managed fall protection program, including policies, duties and training; fall protection procedures; eliminating and controlling fall hazards; rescue procedures; incident investigations; and evaluating program effectiveness.

2. Correct fit of a Full Body Harness is essential to proper performance. Users must be trained to select the size and maintain the fit of their Full Body Harness.

3. Users must follow manufacturer's instructions for proper fit and sizing, paying particular attention to ensure that buckles are connected and aligned correctly, leg straps and shoulder straps are kept snug at all times, chest straps are located in the middle chest area and leg straps are positioned and snug to avoid contact with the genitalia should a fall occur.

4. Full Body Harnesses which meet ANSI/ASSE Z3591) are intended to be used with other components of a Personal Fall Arrest system that limit maximum arrest forces to 1800 pounds (8 kN) or less.

5. Suspension intolerance, also called suspension trauma or orthostatic intolerance, is a serious condition that can be controlled with good harness design, prompt rescue and post fall suspension relief devices. A conscious user may deploy a suspension relief device allowing the user to remove tension from around the legs, freeing blood flow, which can delay the onset of suspension intolerance. An attachment element extender is not intended to be attached directly to an anchorage or anchorage connector for fall arrest. An energy absorber must be used to limit maximum arrest forces to 1800 pounds (8 kN); the length of the attachment element extender may affect free fall distances and free fall clearance calculations.

6. Full Body Harness (FBH) Stretch, the amount the FBH component of a personal fall arrest system will stretch and deform during a fall, can contribute to the overall elongation of the system in stopping a fall. It is important to include the increase in fall distance created by FBH Stretch, as well as the FBH connector length, the settling of the user's body in the FBH and all other contributing factors when calculating total clearance required for a particular fall arrest system.

7. When in use, unused lanyard legs that are still attached to a Full Body Harness D-ring should not be attached to a work positioning element or any other structural element on the Full Body Harness unless deemed acceptable by the competent person and manufacturer of the lanyard. This is especially important when using some types of "Y" style lanyards, as if some load may be transmitted to the user through the unused lanyard leg if it is not able to release from the harness. The lanyard parking attachment is generally located in the sternal area to help reduce tripping and entanglement hazards.

8. Loose ends of straps can get caught in machinery or cause accidental disengagement of an adjuster. All Full Body Harnesses shall include keepers or other components which serve to control the loose ends of straps.

9. Due to the nature of soft loop connections, it is recommended that soft loop attachments only be used to connect with other soft loops or carabiners. Snaphooks should not be used unless approved for the application by the manufacturer.

Sections 10–16 provide additional information concerning the location and use of various attachments that may be provided on this FBH.

10. Dorsal – the dorsal attachment element shall be used as the primary fall arrest attachment, unless the application allows the use of an alternate attachment. the dorsal attachment may also be used for travel restraint or rescue. When supported by the dorsal attachment during a fall, the design of the Full Body Harness shall direct load through the shoulder straps supporting the user, and around the thighs. Supporting the user, post fall, by the dorsal attachment will result in an upright body position with a slight lean to the front with some slight pressure to the lower chest. considerations should be made when choosing a sliding versus fixed dorsal attachment element. Sliding dorsal attachments are generally oriented to adjust to different user sizes, and allow a more vertical rest position post fall, but can increase FBH Stretch.

11. Sternal – the sternal attachment may be used as an alternative fall arrest attachment in applications where the dorsal attachment is determined to be inappropriate by a competent person, and where there is no chance to fall in a direction other than feet first. Accepted practical uses for a sternal attachment include, but are not limited to, ladder climbing with a guided type fall arrester, ladder climbing with an overhead self-retracting lifeline for fall arrest, work positioning and rope access. the sternal attachment may also be used for

travel restraint or rescue.

When supported by the sternal attachment during a fall, the design of the Full Body Harness shall direct load through the shoulder straps supporting the user, and around the thighs. Supporting the user, post fall, by the sternal attachment will result in roughly a sitting or cradled body position with weight concentrated on the thighs, buttocks and lower back. Supporting the user during work positioning by this sternal attachment will result in an approximate upright body position. If the sternal attachment is used for fall arrest the competent person evaluating the application should take measures to ensure that a fall can only occur feet first This may include limiting the allowable free fall distance. it may be possible for a sternal attachment incorporated into an adjustable style chest strap to cause the chest strap to slide up and possibly choke the user during a fall, extraction, suspension, etc. The competent person should consider Full Body Harness models with a fixed sternal attachment for these applications.

12. Frontal – the frontal attachment serves as a ladder climbing connection for guided type fall arresters where there is no chance to fall in a direction other than feet first, or may be used for work positioning. Supporting the user, post fall or during work positioning, by the frontal attachment will result in a sitting body position, with the upper torso upright, with weight concentrated on the thighs and buttocks. When supported by the frontal attachment the design of the Full Body Harness shall direct load directly around the thighs and under the buttocks by means of the sub-pelvic strap.

If the frontal attachment is used for fall arrest the competent person evaluating the application should take measures to ensure that a fall can only occur feet first This may include limiting the allowable free fall distance.

13. Shoulder – the shoulder attachment elements shall be used as a pair, and are an acceptable attachment for rescue and entry/retrieval. the shoulder attachment elements shall not be used for fall arrest. it is recommended that the shoulder attachment elements be used in conjunction with a yoke which incorporates a spreader element to keep the Full Body Harness shoulder straps separate.

14. Waist, Rear – the waist, rear attachment shall be used solely for travel restraint. the waist, rear attachment element shall not be used for fall arrest. Under no circumstances is it acceptable to use the waist, rear attachment for purposes other than travel restraint. the waist, rear attachment shall only be subjected to minimal loading through the waist of the user, and shall never be used to support the full weight of the user.

15. Hip – the hip attachment elements shall be used as a pair, and shall be used solely for work positioning. the hip attachment elements shall not be used for fall arrest. Hip attachments are often used for work positioning by arborists, utility workers climbing poles and construction workers tying rebar and climbing on form walls. Users are cautioned against using the hip attachment elements (or any other rigid point on the Full Body Harness) to store the unused end of a fall arrest lanyard, as this may cause a tripping hazard, or, in the case multiple leg lanyards, could cause adverse loading to the Full Body Harness and the wearer through the unused portion of the lanyard.

16. Suspension seat – the suspension seat attachment elements shall be used as a pair, and shall be used solely for work positioning. the suspension seat attachment elements shall not be used for fall arrest. Suspension seat attachments are often used for prolonged work activities where the user is suspended, allowing the user to sit on the suspension seat formed between the two attachment elements. An example of this use would be window washers on large buildings.

USER INSPECTION, MAINTENANCE AND STORAGE OF EQUIPMENT

Users of personal fall arrest systems shall, at a minimum, comply with all manufacturer instructions regarding the inspection, maintenance and storage

of the equipment. the user's organization shall retain the manufacturer's instructions and make them readily available to all users. See ANSI/ASSE Z3592, Minimum Requirements for a Comprehensive Managed Fall Protection Program, regarding user inspection, maintenance and storage of equipment.

1. In addition to the inspection requirements set forth in the manufacturer's instructions, the equipment shall be inspected by the user before each use and, additionally, by a competent person, other than the user, at interval of no more than one year for:
 - Absence or illegibility of markings.
 - Absence of any elements affecting the equipment form, fit or function.
 - Evidence of defects in, or damage to, hardware elements including cracks, sharp edges, deformation, corrosion, chemical attack, excessive heating, alteration and excessive wear.
 - Evidence of defects in, or damage to strap or ropes including fraying, unsplicing, elongation, kinking, knotting, roping, broken or pulled stitches, excessive unloading, chemical attack, excessive soiling, abrasion, alteration, needed or excessive lubrication, excessive aging and excessive wear.
2. Inspection criteria for the equipment shall be set by the user's organization. Such criteria for the equipment shall equal or exceed the criteria established by this standard or the manufacturer's instructions, whichever is greater.
3. When inspection reveals defects in, damage to, or inadequate maintenance of equipment, the equipment shall be permanently removed from service or undergo adequate corrective maintenance, by the original equipment manufacturer or their designate, before return to service.

MAINTENANCE AND STORAGE

1. Maintenance and storage of equipment shall be conducted by the user's organization in accordance with the manufacturer's instructions. Unique issues, which may arise due to conditions of use, shall be addressed with the manufacturer.
2. Equipment which is in need of, or scheduled for, maintenance shall be tagged as unusable and removed from service.
3. Equipment shall be stored in a manner as to preclude damage from environmental factors such as temperature, light, UV, excessive moisture, oil, chemicals and their vapors or other degrading elements.

ADDITIONAL ANSI INFORMATION

This product makes part of fall arrest system. It is designed to be used for with a dynamic mountaineering rope or low-stretch rope. If the fall arrest system consists of static equipment alone (low-stretch rope, tape slings...) and if there is risk of a fall, it is essential to introduce a shock absorber (EN 355, ANSI Z359.13, CSA Z259.11) into the safety chain to lower the potential shock load. Do not use when the fall arrest indicator is deployed or visible. Be vigilant when working near sources of electricity, moving machinery or abrasive or sharp surface.

A product must be retired when:

- It is over 15 years old or after 10 years since the date of first use
- It has been subjected to a major fall (or load).
- It fails to pass inspection. You have any doubt as to its reliability.
- You do not know its full usage history.
- When it becomes obsolete due to changes in legislation, standards, technique or incompatibility with other equipment.

Destroy these products to prevent further use.

In a fall, the fall arrest attachment point elongates (max. 45 cm). This elongation must be taken into account for the clearance calculation. For the clearance calculation, take into account the length of any connectors that will have an effect on the fall distance.

Please check instructions for interfere with the safe function.

A EN 361:2002

Použití pro zachycení pádu. Součástí systému zachycení pádu. Use for fall arrest purposes. Component part of a fall-arrest system. Verwendung als auffanggerät. Teil eines Auffangsystems. Utilisation en harnais antichute. Composante d' un système d' arrêt des chutes. Utilización como arnés anticaída. Componente de un sistema anticaídas. Utilizzo come imbracatura anticaduta. Componente di un sistema d' arresto anticaduta.

Uzycie dla zatrzymywania upadku. Czesć sposobu chwywania upadku.

B EN 813:2008

Použití jako sedací pracovní úvaz. Sedací úvaz samotný není určen pro zachycení pádu. Use as sit harness. Sit harness alone is not suitable for fall arrest purposes. Verwendung als Sitzgurt. Sitzgurt allein ist nicht geeignet zu verwenden als auffanggerät. Utilisation en harnais cussard professionnel. Harnais cussard professionnel ne doit pas être utiliser comme antichute. Utilisación como arnés profesional de cintura. Arnés profesional de cintura no debe ser utilizado como un quipo anticaída. Utilizzo come imbracatura bassa professionale. Imbracatura bassa professionale non deve essere utilizzato come anticaduta. Uzycie oraz uprzaz biodrowa robocza. Uprzaz biodrowa nie jest przystosowana do wykonywania celowych upadków.

C EN 358:2018

Použití jako polohovací pás. Kotvicí prvky na polohovacím pasu – nepoužívat pro zachycení pádu! Use as work positioning harness. Component part of a work positioning system – not use as fall arrester! Verwendung als Ruckhaltegurt. Teil eines Ruckhaltegurt – nicht als auffanggerät verwenden! Utilisation en ceinture de maintien. Composante d' un système de maintien au travail – ne doit pas être utiliser comme antichute! Utilisación como cintura de sujeción. Componente de un sistema de sujeciónno debe ser utilizado como un equipo anticadida! Utilizzo come cintura di sostegno. Componente di un sistema di sostegno da lavoro – non deva essere utilizzato comeanticaduta! Uzyciew pozycji roboczej. Komponenty pozycyjne – nie uzywac do wykonywania celowych upadkow!

D EN 1497:2007

Prostředky ochrany osob proti pádu – Záchranné postroje. Personal fall protection equipment – Rescue harnesses. Persönliche Absturzschutzausrüstungen – Rettungsgurte. Equipment de protection personnel contre les chutes – Harnais de sauvetage. Equipo de salvamento – Arnéses de salvamento. Dispositivi individuali per la protezione contro le cadute – Imbracature di salvataggio. Sprzet ratowniczy – Szelki ratownicze.