

PITON A3

RK708

Tvrzená ocelová skoba pro úzké spáry a trhliny.

CE 1019

EN 569:07



RK708XX03 - L3
RK708XX05 - L5
RK708XX07 - L7



Reading and understanding instruction for use are required to use this product!
Bez důkladného pročetí a pochopení návodu k použití nepoužívejte tento výrobek

Material
Materiál Cr-Mo ocel

Weight
Váha 54 g (L5)
1.9 oz (L5)

Thickness
Šířka 3 mm

Blade length
Délka čepele 3, 5, 7 cm
1.2, 2, 2.8 in

Instalace:

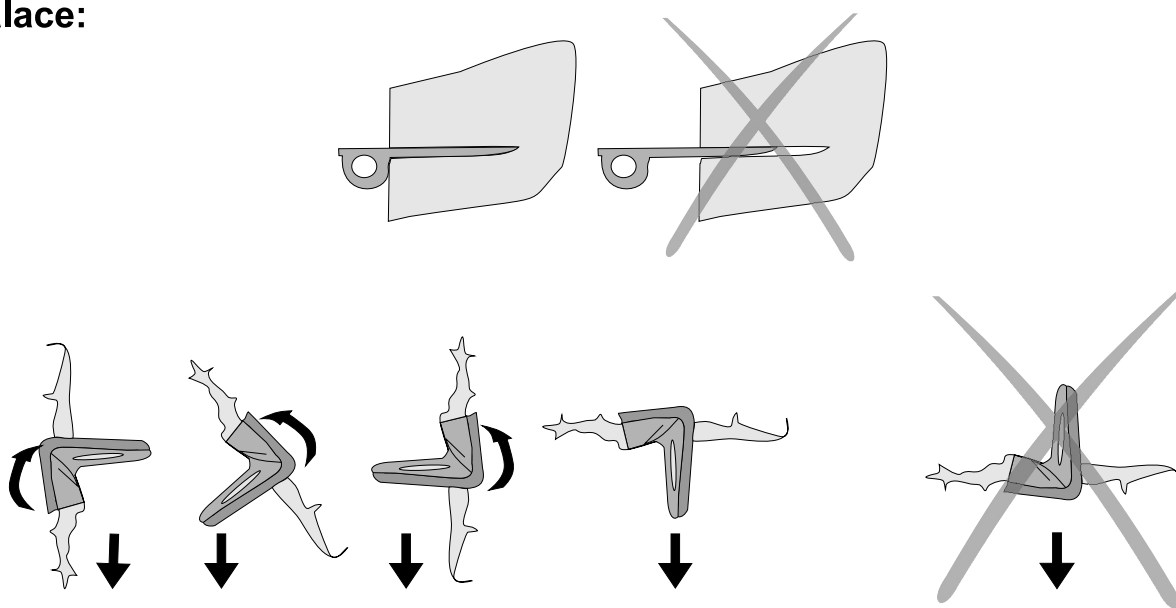

Technická data:

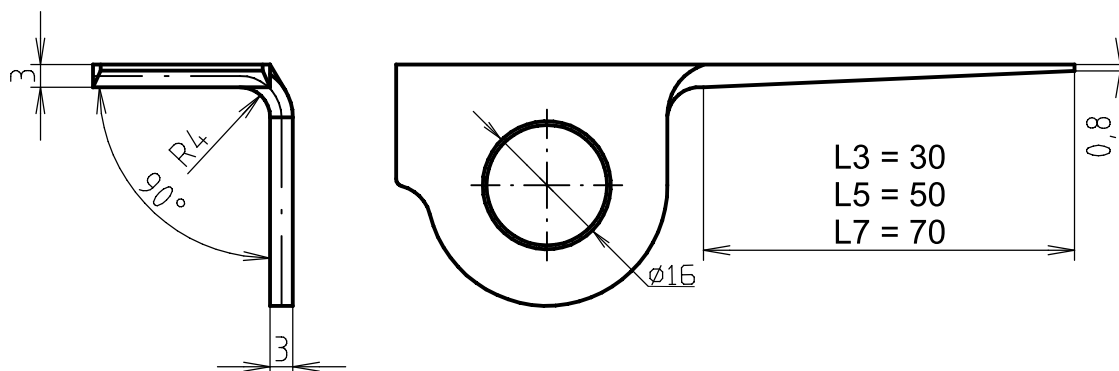

Údržba:

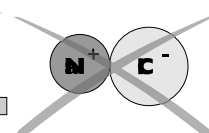
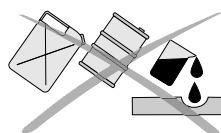
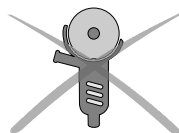
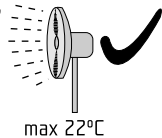
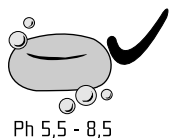
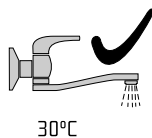

SINGING ROCK

Let's rock!